

SPECIFICATIONS

CONTACT RATING: Dependent upon contact material See Page 87.

MECHANICAL LIFE: 30,000 make-and-break cycles.

CONTACT RESISTANCE: 10 mΩ max. initial @ 2-4VDC
100mA for both silver and gold plated contacts.

INSULATION RESISTANCE: 1,000 MΩ min.

DIELECTRIC STRENGTH: 1,000 Vrms min. @sea level.

OPERATING TEMPERATURE: -30°C to 85°C.

MATERIALS

CASE: Diallyl phthalate (DAP) (UL94v-0).

HOUSING: Stainless Steel.

ACTUATOR: Nylon,black std.

CONTACT: Brass,with silver or gold plated.

TERMINAL SEAL: Epoxy. (See Page 87)

5M Slide Switches

HOW TO ORDER

MODEL NO. ACTUATOR ACTUATOR COLOR MOUNTING EARS TERMINATIONS CONTACT MATERIAL SEAL ROHS SOLDERING

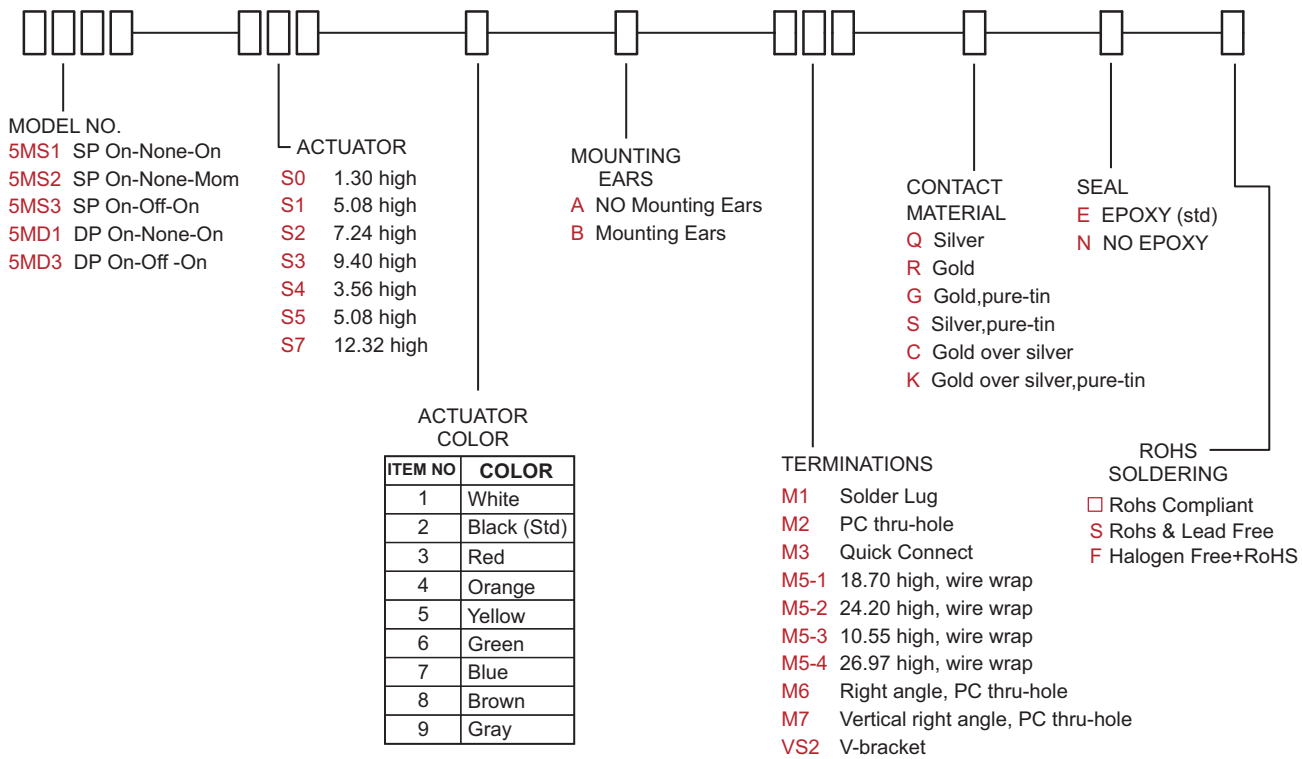

SWITCH FUNCTION

NO. POLES	UL/CSA MODEL NO.	MODEL NO.	SWITCH FUNCTION			CONNECTED TERMINALS / SCHEMATIC		
			POS.1	POS.2	POS.3	POS.1	POS.2	POS.3
SP	Q1511	5MS1	ON	NONE	ON	2-1	N/A	2-3
	Q1512	5MS2	ON	NONE	MOM		OPEN	
	Q1513	5MS3	ON	OFF	ON			
DP	Q1521	5MD1	ON	NONE	ON	2-1,5-4	N/A	2-3,5-6
	Q1523	5MD3	ON	OFF	ON		OPEN	

MOM=MOMENTARY

POLE OPTIONS

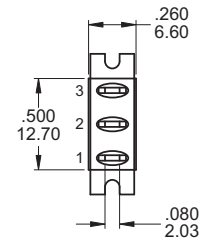
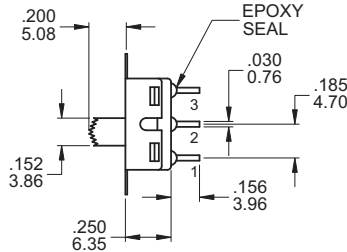
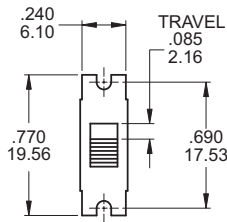
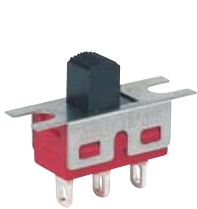

SPDT

Part No. Shown : 5MS1S102BM1QE

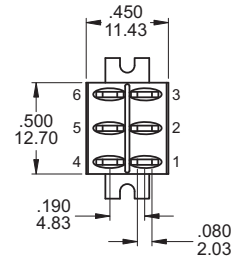
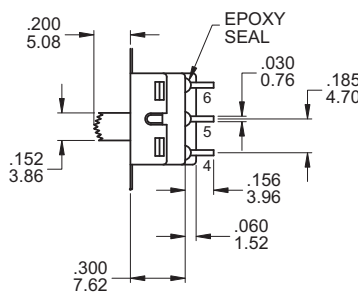
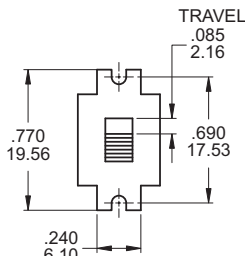
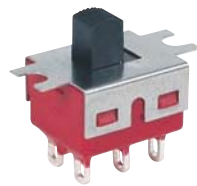

DPDT

Part No. Shown : 5MD1S102BM1QE

ACTUATOR OPTIONS

S1 STD

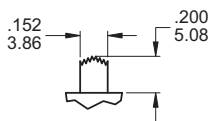

S2

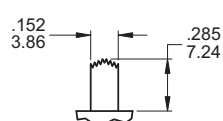

S0

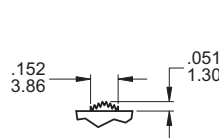

FRONT

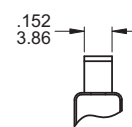

For S0,S1,S2,S3,S4

▲ S5

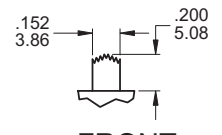

FRONT

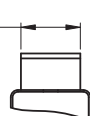

FOR DPDT ONLY

S3

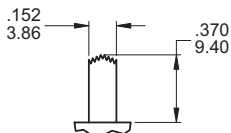

S4

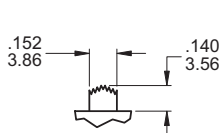

S7

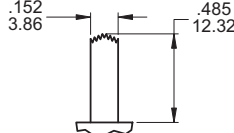

* Subtract .014(0.36) from Actuator height for M6, M7 P.C. MOUNTING OPTION.

TERMINATION OPTIONS

M1 SOLDER LUG

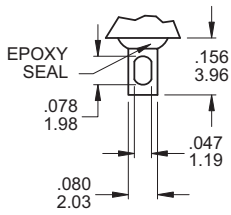

.030(0.76) THK.

M2 PC THRU-HOLE

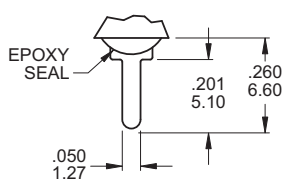

.030(0.76) THK.

M3 QUICK CONNECT

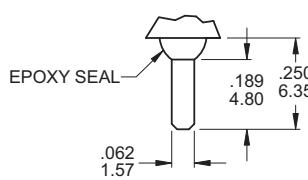

THK .030(0.76)

M5 WIRE WRAP

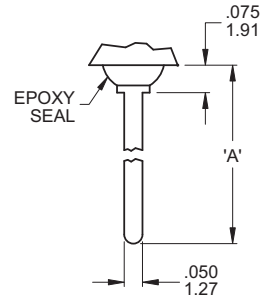

THK .030(0.76)

OTHER TERMINATION OPTIONS

- M6 RIGHT ANGLE P.C. MOUNT
- M7 RIGHT ANGLE P.C. MOUNT
- VS2 VERTICAL BRACKET P.C. MOUNT

OPTION CODE	DIM. 'A'
M5-1	.736 (18.70)
M5-2	.953 (24.20)
M5-3	.415 (10.55)
M5-4	1.062 (26.97)

5M Slide Switches

M6

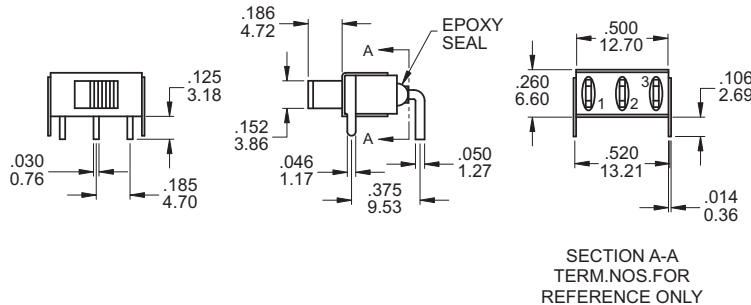

P.C. MOUNTING

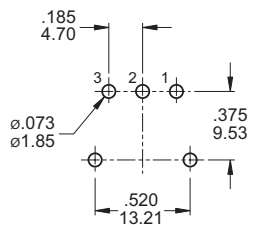

SPDT

Part No. Shown : 5MS1S102AM6QE

M6

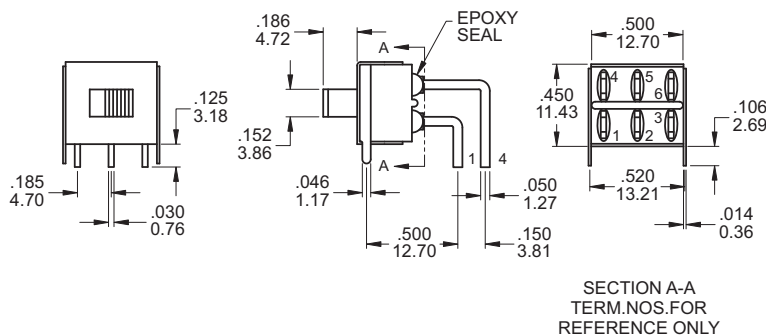

P.C. MOUNTING

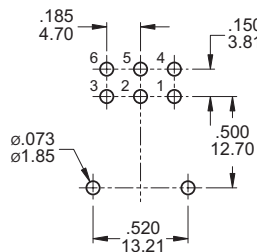

DPDT

Part No. Shown : 5MD1S102AM6QE

M7

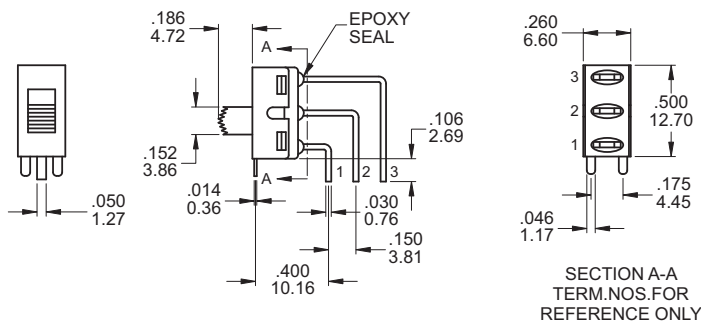

P.C. MOUNTING

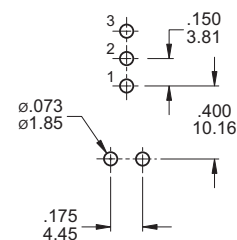

SPDT

Part No. Shown : 5MS1S102AM7QE

M7

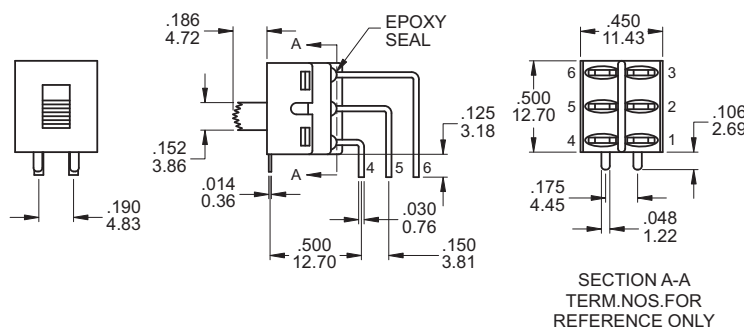
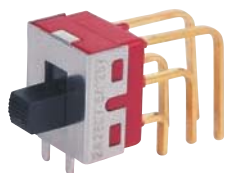

P.C. MOUNTING

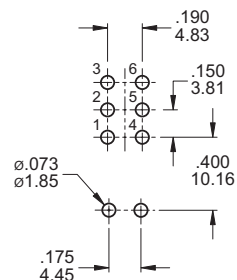

DPDT

Part No. Shown : 5MD1S102AM7RE

VS2

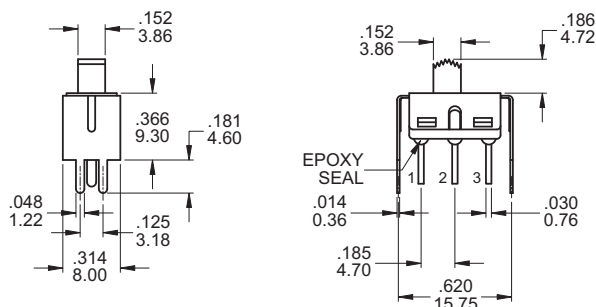
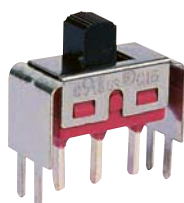

P.C. MOUNTING

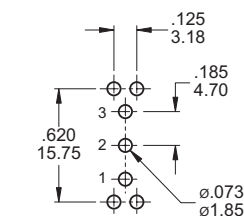

SPDT

Part No. Shown : 5MS1S102AVS2QE

VS2

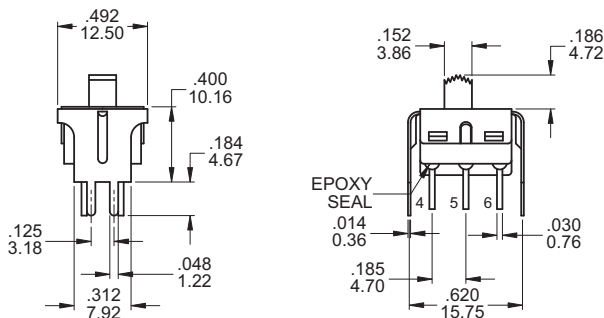
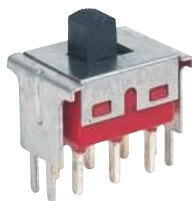

P.C. MOUNTING

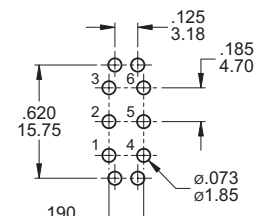

DPDT

Part No. Shown : 5MD1S102AVS2QE



MOUNTING EARS / PANEL MOUNTING

MOUNTING EARS

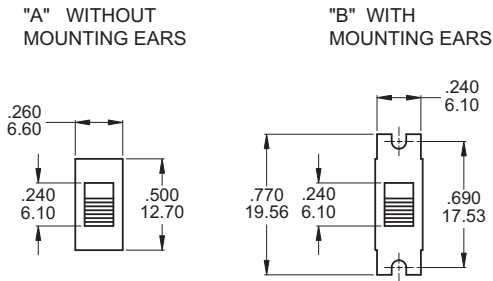

THREE POSITIONS ONLY

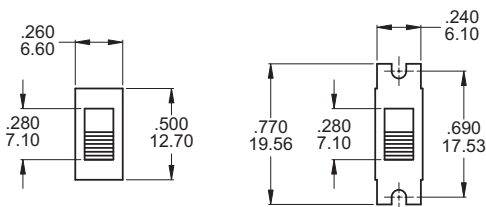

PANEL MOUNTING

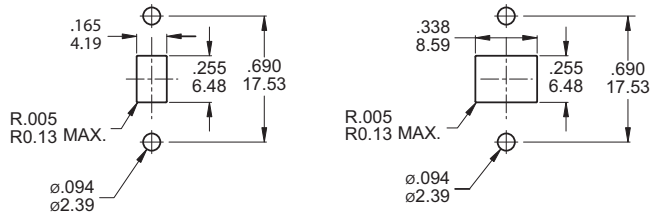

For S0,S1,S2,S3,S4

For S5 ONLY

THREE POSITIONS ONLY

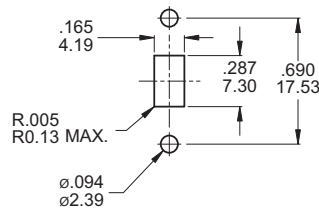

For S0,S1,S2,S3,S4

CONTACT MATERIAL OPTIONS

	CONTACT PLATING	TERMINAL PLATING	RATINGS
Q	Silver	Q = Silver	5 Amps with resistant load @ 120VAC or 28VDC 2 Amps with resistant load @ 250VAC
S		S = Silver,pure - tin	
C	Gold over Silver	C = Gold over silver	
K		K = Gold over silver,pure - tin	
R	Gold	R = Gold	0.4 Volt - Amps (VA) max. @ 20V max. (AC or DC)
G		G = Gold,pure - tin	

SOLDERING PROCESSES

MANUAL SOLDERING : Use soldering iron of 30 watts, controlled st 350°C approximately 5 seconds while applying solder.

WAVE SOLDERING : Recommended Soldering Temperature : 260 ± 5°C
Duration of Solder Immersion : Max 5 sec.
(PCB is 1.6mm in thickness)

SOLDERING : Vapor phase